

MEASURING TAPES

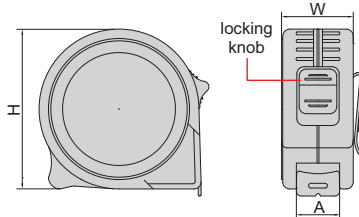

- Non-glare nylon surface for wear resistance

| Code | Range | Graduation | Width of tape A | W | H |
|--------|-------|------------|-----------------|------|------|
| 7140-3 | 0-3m | 1mm | 16mm | 28mm | 62mm |
| 7140-5 | 0-5m | 1mm | 19mm | 30mm | 68mm |
| 7140-8 | 0-8m | 1mm | 25mm | 38mm | 78mm |



7140-5

graduation



packaging



EG II

MEASURING TAPE (BASIC TYPE)

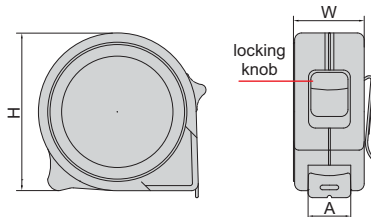

- Non-glare nylon coating tape, wear resistance

| Code | Range | Graduation | Width of tape A | W | H |
|--------|-------------|------------|-----------------|------|------|
| 7142-5 | 0-5m/0-16ft | 1mm, 1/16" | 19mm | 31mm | 64mm |



7142-5

graduation



packaging

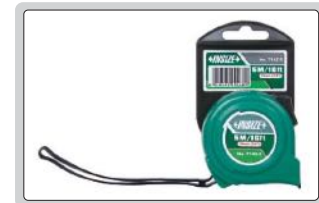

EG II

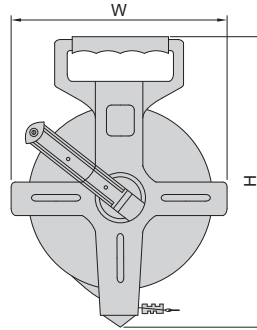
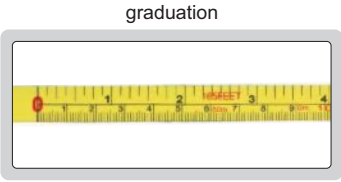

7143-50

- High tensile strength fibreglass tape
- Nylon coating tape, wear resistance

| Code | Range | Graduation | Width of tape | W | H |
|---------|---------------|------------|---------------|-------|-------|
| 7143-50 | 0-50m/0-165ft | 1mm, 1/8" | 13mm | 220mm | 320mm |

MEASURING WHEEL (BASIC TYPE)

- ABS plastic frame, wear-resistant PU tire
- Three-section adjustable handle



7144-1

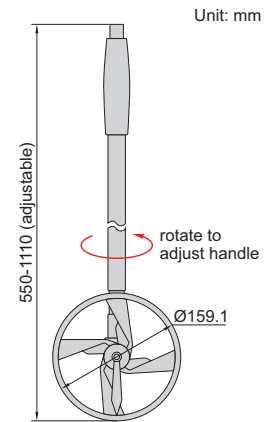

| Code | Range | Resolution |
|--------|-------------|------------|
| 7144-1 | 0.1-9999.9m | 0.1m |

- ABS plastic frame, wear-resistant PU tire
- Two-section foldable handle



after folding



backpack (included)



7145-1

MEASURING WHEEL

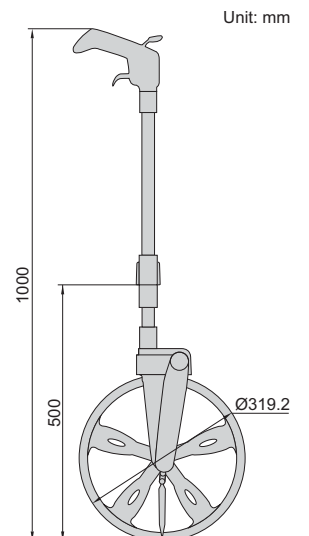

| Code | Range | Resolution |
|--------|-------------|------------|
| 7145-1 | 0.1-9999.9m | 0.1m |