

DIGITAL DRUM BRAKE CALIPER

DATA OUTPUT

calibration block (included)

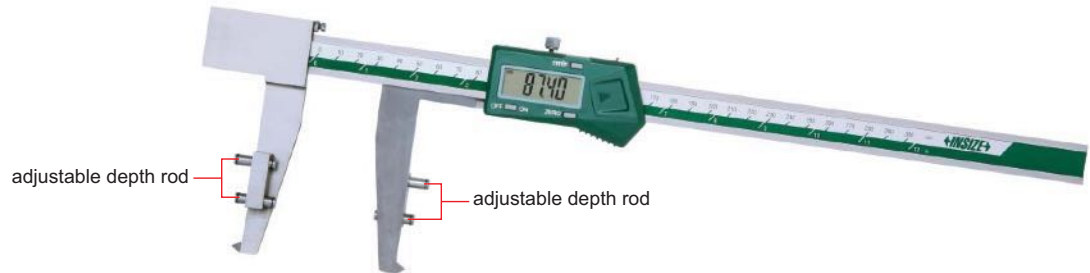

1538-300

- Measure internal diameter of drum brakes
- Resolution: 0.01mm/0.0005"
- Buttons: on/off, zero, mm/inch
- Automatic power off, move the digital unit to turn on power
- Battery CR2032
- Data output
- Made of stainless steel
- Optional accessory: data output cable (code 7315-22, 7302-22)

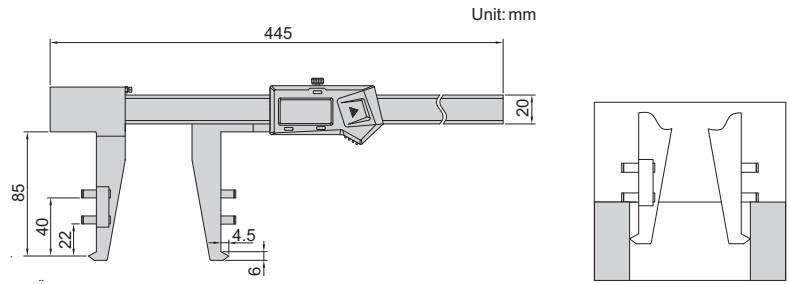

Code	Range	Accuracy
1538-300	30-300mm/1.2-12"	±0.05mm

ATTENTION: IT IS NECESSARY TO SET ZERO AFTER POWER ON EACH TIME

IP67 WATERPROOF DIGITAL DEPTH GAGES

- IP67 dust/waterproof
- Resolution: 0.01mm/0.0005"
- Button function: zero, on/off, mm/inch, ABS/REL, hold
- Meet DIN862
- Battery CR2032
- Made of stainless steel



1149-150

IP67 WATERPROOF

ATTENTION: NO DATA OUTPUT

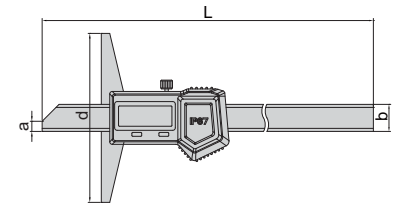

Code	Range	Accuracy	L	a	b	d
1149-150	0-150mm/0-6"	±0.03mm	240mm	6mm	16mm	100mm
1149-200	0-200mm/0-8"	±0.03mm	290mm	6mm	16mm	100mm
1149-300	0-300mm/0-12"	±0.03mm	390mm	6mm	16mm	150mm

ATTENTION: NO DATA OUTPUT

IP67 WATERPROOF

IP67 WATERPROOF DIGITAL DEPTH GAGES

- IP67 dust/waterproof
- Resolution: 0.01mm/0.0005"
- Large display
- Button function: zero, on/off, mm/inch
- Battery CR2032, automatic power off
- Meet DIN862
- Made of stainless steel



1541-150

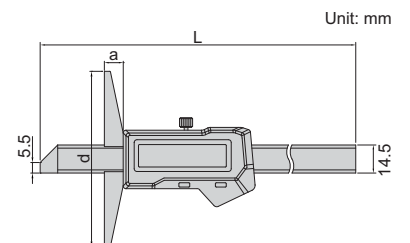

Code	Range	Accuracy	L	a	d
1541-150	0-150mm/0-6"	±0.03mm	232.5mm	11mm	100mm
1541-200	0-200mm/0-8"	±0.03mm	285mm	11mm	100mm
1541-300	0-300mm/0-12"	±0.03mm	390mm	13.5mm	150mm

DIGITAL DEPTH GAGES (STANDARD TYPE)

3

- Buttons: on/off, zero, mm/inch
- Automatic power off, move the digital unit to turn on power
- Meet DIN862 (except 0-500mm/0-20", 0-1000mm/0-40", 0-1500mm/0-60")
- Battery CR2032
- Made of stainless steel



1141-150A

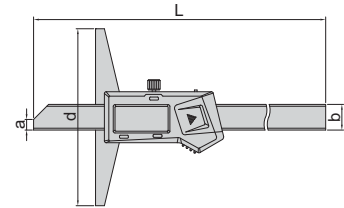

With data interface

Code	Range	Resolution	Accuracy	L	a	b	d	Data output cable (optional)
1141-150A	0-150mm/0-6"	0.01mm/0.0005"	±0.03mm	230mm	6mm	14.5mm	100mm	7315-21, 7302-21
1141-200A	0-200mm/0-8"	0.01mm/0.0005"	±0.03mm	280mm	6mm	14.5mm	100mm	7315-21, 7302-21
1141-300A	0-300mm/0-12"	0.01mm/0.0005"	±0.03mm	380mm	6mm	14.5mm	150mm	7315-21, 7302-21
1141-500A	0-500mm/0-20"	0.01mm/0.0005"	±0.05mm	585mm	7mm	15mm	150mm	7315-21, 7302-21
1141-5001A	0-500mm/0-20"	0.01mm/0.0005"	±0.05mm	585mm	7mm	15mm	200mm	7315-21, 7302-21
1141-1000A	0-1000mm/0-40"	0.01mm/0.0005"	±0.07mm	1188mm	7mm	18mm	150mm	7315-22, 7302-22
1141-10001A	0-1000mm/0-40"	0.01mm/0.0005"	±0.07mm	1188mm	7mm	18mm	200mm	7315-22, 7302-22
1141-10002A	0-1000mm/0-40"	0.01mm/0.0005"	±0.07mm	1188mm	7mm	18mm	250mm	7315-22, 7302-22
1141-10003A	0-1000mm/0-40"	0.01mm/0.0005"	±0.07mm	1188mm	7mm	18mm	300mm	7315-22, 7302-22
1141-1500A	0-1500mm/0-60"	0.01mm/0.0005"	±0.11mm	1695mm	7mm	18mm	200mm	7315-22, 7302-22

Built-in wireless

Code	Range	Resolution	Accuracy	L	a	b	d
1141-150AWL	0-150mm/0-6"	0.01mm/0.0005"	±0.03mm	230mm	6mm	14.5mm	100mm
1141-200AWL	0-200mm/0-8"	0.01mm/0.0005"	±0.03mm	280mm	6mm	14.5mm	100mm
1141-300AWL	0-300mm/0-12"	0.01mm/0.0005"	±0.03mm	380mm	6mm	14.5mm	150mm
1141-500AWL	0-500mm/0-20"	0.01mm/0.0005"	±0.05mm	585mm	7mm	15mm	150mm
1141-5001AWL	0-500mm/0-20"	0.01mm/0.0005"	±0.05mm	585mm	7mm	15mm	200mm

DIGITAL HOOK DEPTH GAGES

- Resolution: 0.01mm/0.0005"
- Buttons: on/off, zero, mm/inch
- Automatic power off, move the digital unit to turn on power
- Battery CR2032
- Made of stainless steel



1142-150A

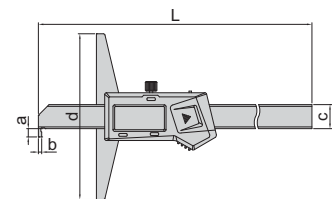

With data interface

Code	Range	Accuracy	L	d	a	b	c	Data output cable (optional)
1142-150A	0-150mm/0-6"	±0.03mm	230mm	100mm	5mm	2mm	14.5mm	7315-21, 7302-21
1142-200A	0-200mm/0-8"	±0.03mm	280mm	100mm	5mm	2mm	14.5mm	7315-21, 7302-21
1142-300A	0-300mm/0-12"	±0.04mm	380mm	150mm	5mm	2mm	14.5mm	7315-21, 7302-21
1142-500A	0-500mm/0-20"	±0.05mm	585mm	150mm	8mm	3mm	15mm	7315-21, 7302-21
1142-5001A	0-500mm/0-20"	±0.05mm	585mm	200mm	8mm	3mm	15mm	7315-21, 7302-21
1142-1000A	0-1000mm/0-40"	±0.07mm	1188mm	150mm	10mm	4mm	18mm	7315-22, 7302-22
1142-10001A	0-1000mm/0-40"	±0.07mm	1188mm	200mm	10mm	4mm	18mm	7315-22, 7302-22
1142-10002A	0-1000mm/0-40"	±0.07mm	1188mm	250mm	10mm	4mm	18mm	7315-22, 7302-22

Built-in wireless

Code	Range	Accuracy	L	d	a	b	c
1142-150AWL	0-150mm/0-6"	±0.03mm	230mm	100mm	5mm	2mm	14.5mm
1142-200AWL	0-200mm/0-8"	±0.03mm	280mm	100mm	5mm	2mm	14.5mm
1142-300AWL	0-300mm/0-12"	±0.04mm	380mm	150mm	5mm	2mm	14.5mm
1142-500AWL	0-500mm/0-20"	±0.05mm	585mm	150mm	8mm	3mm	15mm
1142-5001AWL	0-500mm/0-20"	±0.05mm	585mm	200mm	8mm	3mm	15mm

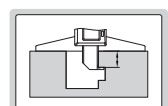
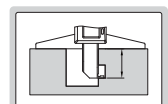
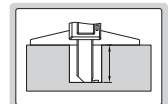

DIGITAL DOUBLE HOOK DEPTH GAGES

DATA OUTPUT

- Resolution: 0.01mm/0.0005"
- Buttons: on/off, zero, mm/inch
- Automatic power off, move the digital unit to turn on power
- Meet DIN862
- Battery CR2032
- Made of stainless steel



1144-150A

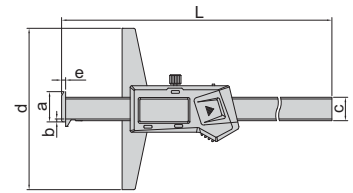

With data interface

Code	Range	Accuracy	L	d	a	b	c	e	Data output cable (optional)
1144-150A	0-150mm/0-6"	±0.03mm	233mm	100mm	21.5mm	3.5mm	14.5mm	2.5mm	7315-21, 7302-21
1144-200A	0-200mm/0-8"	±0.03mm	283mm	100mm	21.5mm	3.5mm	14.5mm	2.5mm	7315-21, 7302-21
1144-300A	0-300mm/0-12"	±0.03mm	383mm	150mm	21.5mm	3.5mm	14.5mm	2.5mm	7315-21, 7302-21
1144-500A	0-500mm/0-20"	±0.05mm	585mm	150mm	25mm	5mm	15mm	3mm	7315-21, 7302-21
1144-5001A	0-500mm/0-20"	±0.05mm	585mm	200mm	25mm	5mm	15mm	3mm	7315-21, 7302-21
1144-1000A	0-1000mm/0-40"	±0.07mm	1188mm	150mm	32mm	7mm	18mm	4mm	7315-22, 7302-22
1144-10001A	0-1000mm/0-40"	±0.07mm	1188mm	200mm	32mm	7mm	18mm	4mm	7315-22, 7302-22
1144-10002A	0-1000mm/0-40"	±0.07mm	1188mm	250mm	32mm	7mm	18mm	4mm	7315-22, 7302-22

Built-in wireless

Code	Range	Accuracy	L	d	a	b	c	e
1144-150AWL	0-150mm/0-6"	±0.03mm	233mm	100mm	21.5mm	3.5mm	14.5mm	2.5mm
1144-200AWL	0-200mm/0-8"	±0.03mm	283mm	100mm	21.5mm	3.5mm	14.5mm	2.5mm
1144-300AWL	0-300mm/0-12"	±0.03mm	383mm	150mm	21.5mm	3.5mm	14.5mm	2.5mm
1144-500AWL	0-500mm/0-20"	±0.05mm	585mm	150mm	25mm	5mm	15mm	3mm
1144-5001AWL	0-500mm/0-20"	±0.05mm	585mm	200mm	25mm	5mm	15mm	3mm

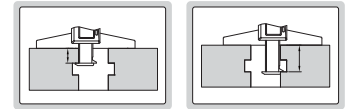

DATA OUTPUT

DIGITAL DEPTH GAGES WITH MOUNTING HOLES FOR EXTENSION BASE

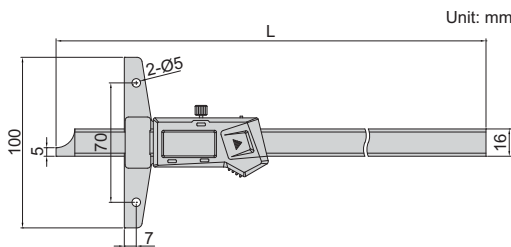

1147-300

extension base (optional)



6141 series

- Resolution: 0.01mm/0.0005"
- Buttons: on/off, zero, mm/inch
- Automatic power off, move the digital unit to turn on power
- Meet DIN862
- Battery CR2032
- Made of stainless steel
- Optional accessory: extension base (code 6141)

With data interface (data output cable code 7315-21, 7302-21, optional)

Code	Range	Accuracy	L (mm)
1147-150	0-150mm/0-6"	±0.03mm	237
1147-200	0-200mm/0-8"	±0.03mm	287
1147-300	0-300mm/0-12"	±0.03mm	403
1147-500	0-500mm/0-20"	±0.05mm	605

Built-in wireless

Code	Range	Accuracy	L (mm)
1147-150WL	0-150mm/0-6"	±0.03mm	237
1147-200WL	0-200mm/0-8"	±0.03mm	287
1147-300WL	0-300mm/0-12"	±0.03mm	403
1147-500WL	0-500mm/0-20"	±0.05mm	605

DATA OUTPUT

DIGITAL POINT DEPTH GAGES

- Resolution: 0.01mm/0.0005"
- Buttons: on/off, zero, mm/inch
- Automatic power off, move the digital unit to turn on power
- Meet DIN862
- Battery CR2032
- Made of stainless steel



1143-200A

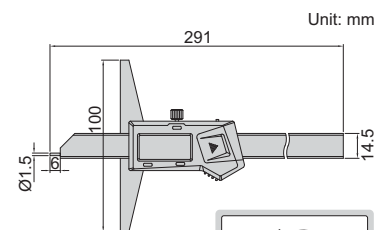

With data interface (data output cable code 7315-21, 7302-21, optional)

Code	Range	Accuracy
1143-200A	0-200mm/0-8"	±0.03mm

Built-in wireless

Code	Range	Accuracy
1143-200AWL	0-200mm/0-8"	±0.03mm

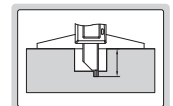

DIGITAL DEPTH GAGES WITH ROUND DEPTH BAR

MEASURE WIDTH AND DEPTH OF GROOVES INSIDE BORE

MEASURE DEPTH OF SMALL HOLES (>Ø4mm)

DATA OUTPUT

3

- Resolution: 0.01mm/0.0005"
- Supplied with three interchangeable points (flat, spherical, disk)
- Buttons: on/off, set, mm/inch, preset (+, -)
- Automatic power off, move the digital unit to turn on power
- Battery CR2032
- Made of stainless steel
- Optional accessory: extension base (code 6141, for 1148-120, 1148-120WL, 1148-200, 1148-200WL, 1148-300 and 1148-300WL)

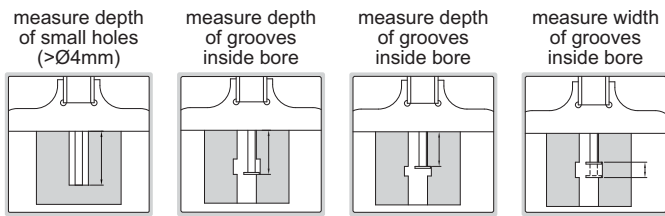
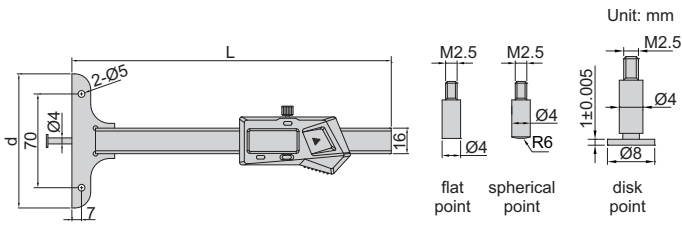

1148-100S



1148-120

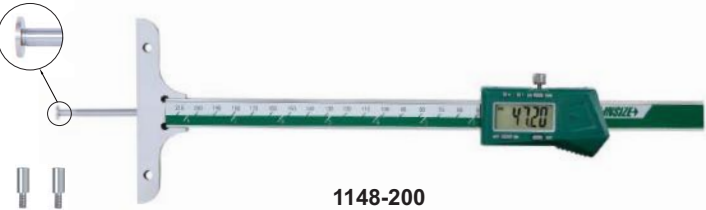

1148-200



With data interface (data output cable code 7315-21, 7302-21, optional)

Code	Range *	Accuracy	L	d	Remark
1148-100S	0-100mm/0-4"	±0.02mm	200mm	45mm	
1148-100	0-100mm/0-4"	±0.02mm	200mm	85mm	
1148-120	0-120mm/0-4.7"	±0.03mm	300mm	101mm	one-hand use, with mounting holes for extension base
1148-200	0-200mm/0-8"	±0.03mm	300mm	101mm	with mounting holes for extension base
1148-300	0-300mm/0-12"	±0.04mm	400mm	101mm	with mounting holes for extension base

one-hand use of 1148-120 and 1148-120WL



extension base for 1148-120, 1148-120WL, 1148-200, 1148-200WL, 1148-300 and 1148-300WL (optional)



Built-in wireless

Code	Range *	Accuracy	L	d	Remark
1148-100SWL	0-100mm/0-4"	±0.02mm	200mm	45mm	
1148-100WL	0-100mm/0-4"	±0.02mm	200mm	85mm	
1148-120WL	0-120mm/0-4.7"	±0.03mm	300mm	101mm	one-hand use, with mounting holes for extension base
1148-200WL	0-200mm/0-8"	±0.03mm	300mm	101mm	with mounting holes for extension base
1148-300WL	0-300mm/0-12"	±0.04mm	400mm	101mm	with mounting holes for extension base

1148-P103 (optional), measure width of bottom grooves inside blind hole

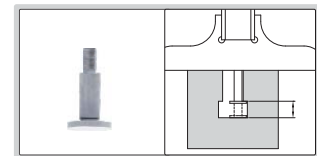

*When disk points are used, the range is reduced by 10mm

OPTIONAL DISK POINTS

Code	Description	H	Remark
1148-P101	0.5mm disk point	0.5±0.005mm	for narrow grooves
1148-P102	0.7mm disk point	0.7±0.005mm	for narrow grooves
1148-P103	1mm disk point	1±0.005mm	for grooves inside blind hole
1148-P104	0.5mm disk point	0.5±0.005mm	for grooves inside blind hole

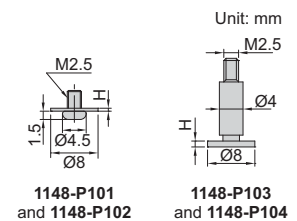

DATA OUTPUT

- Resolution: 0.01mm/0.0005"
- Buttons: on/off, zero, mm/inch, ABS/INC, data hold, TOL, set
- ABS/INC is for absolute and incremental measurement
- TOL is for tolerance measurement
- Made of stainless steel
- LR44 battery, data output
- Supplied with gage block for zero setting
- Optional accessory: extension base, data output cable (code **7302-SPC7**, keyboard format)

gage block for zero setting (included)



data output cable (optional)



Extension base

Code	L
1540-L300	300mm
1540-L400	400mm
1540-L500	500mm
1540-L600	600mm
1540-L800	800mm

Code	Range	Accuracy
1540-300	0-300mm/0-12"	±0.04mm

DIGITAL DOUBLE HOOK DEPTH GAGE

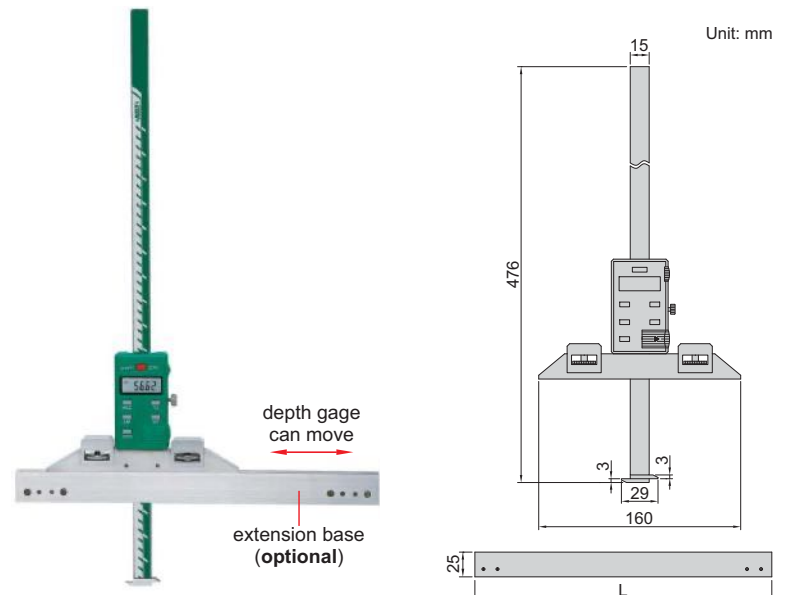

1540-300

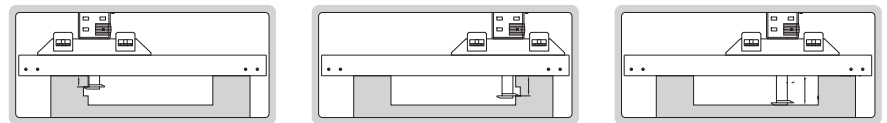

SHOCK PROOF

- Shockproof dial indicator
- Made of stainless steel

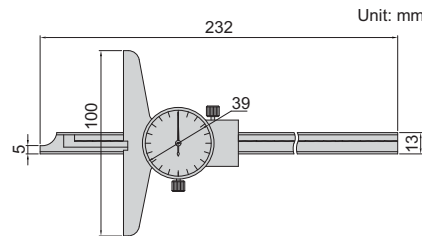

DIAL DEPTH GAGE



1340-150

Code	Range	Graduation	Accuracy
1340-150	0-150mm	0.02mm	±0.03mm

VERNIER DEPTH GAGES (STANDARD TYPE)

- Made of stainless steel
- Satin chrome plated reading surface

Graduation 0.05mm

Code	Range	Accuracy	L	d
1240-150	0-150mm	±0.05mm	245mm	100mm
1240-200	0-200mm	±0.05mm	282mm	100mm
1240-300	0-300mm	±0.08mm	382mm	100mm
1240-500	0-500mm	±0.09mm	585mm	150mm



1240-2001

Graduation 0.02mm

Code	Range	Accuracy	L	d
1240-1501	0-150mm	±0.03mm	245mm	100mm
1240-2001	0-200mm	±0.03mm	282mm	100mm
1240-3001	0-300mm	±0.04mm	382mm	100mm
1240-5001	0-500mm	±0.05mm	585mm	150mm

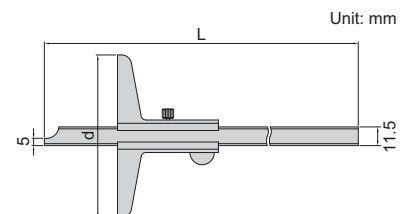

VERNIER DEPTH GAGES

WITH MOUNTING HOLES FOR EXTENSION BASE

extension base (optional)



6141 series

- Made of stainless steel
- Satin chrome plating finish on reading surface
- Optional accessory: extension base (code 6141)

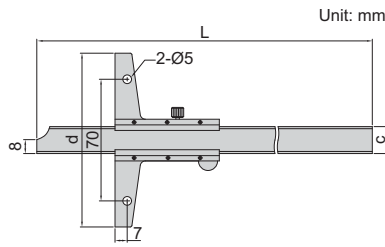

Unit: mm



1247-1501

Graduation 0.05mm

Code	Range	Accuracy
1247-150	0-150mm	±0.05mm
1247-200	0-200mm	±0.05mm
1247-300	0-300mm	±0.08mm
1247-600	0-600mm	±0.10mm
1247-1000	0-1000mm	±0.15mm

Graduation 0.02mm

Code	Range	Accuracy
1247-1501	0-150mm	±0.03mm
1247-2001	0-200mm	±0.03mm
1247-3001	0-300mm	±0.04mm
1247-6001	0-600mm	±0.05mm
1247-1001	0-1000mm	±0.07mm

Range	L	c	d
0-150mm	240mm	11mm	100mm
0-200mm	290mm	11mm	100mm
0-300mm	390mm	11mm	100mm
0-600mm	704mm	16mm	150mm
0-1000mm	1124mm	16mm	200mm

VERNIER DEPTH GAGES WITH FINE ADJUSTMENT

WITH MOUNTING HOLES FOR EXTENSION BASE

- With fine adjustment
- Made of stainless steel
- Satin chrome plating finish on reading surface
- Optional accessory: extension base (code 6141)

Graduation 0.05mm

Code	Range	Accuracy
1249-150	0-150mm	±0.05mm
1249-200	0-200mm	±0.05mm
1249-300	0-300mm	±0.08mm

Graduation 0.02mm

Code	Range	Accuracy
1249-1501	0-150mm	±0.03mm
1249-2001	0-200mm	±0.03mm
1249-3001	0-300mm	±0.04mm

Range	L	c	d
0-150mm	256mm	16mm	100mm
0-200mm	306mm	16mm	100mm
0-300mm	406mm	16mm	100mm

extension base (optional)



6141 series



1249-1501

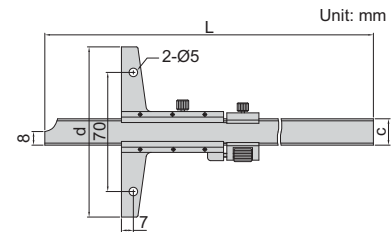

Unit: mm

VERNIER HOOK DEPTH GAGES

WITH MOUNTING HOLES FOR EXTENSION BASE

- Made of stainless steel
- Satin chrome plating finish on reading surface
- Optional accessory: extension base (code 6141)

Graduation 0.05mm

Code	Range	Accuracy	L
1248-150	0-150mm	±0.05mm	266mm
1248-200	0-200mm	±0.05mm	316mm
1248-300	0-300mm	±0.08mm	416mm

Graduation 0.02mm

Code	Range	Accuracy	L
1248-1501	0-150mm	±0.03mm	266mm
1248-2001	0-200mm	±0.03mm	316mm
1248-3001	0-300mm	±0.04mm	416mm

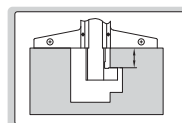
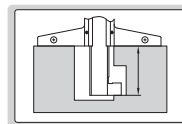
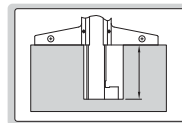

extension base (optional)



6141 series



1248-1501

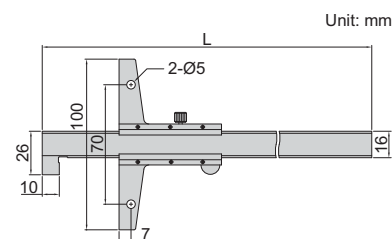

Unit: mm

VERNIER HOOK DEPTH GAGE



1243-2001

- Graduation 0.02mm
- Made of stainless steel
- Satin chrome plating finish on reading surface

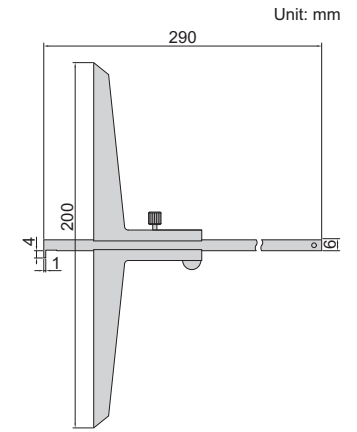

Unit: mm

Code	Range	Accuracy
1243-2001	0-200mm	±0.03mm

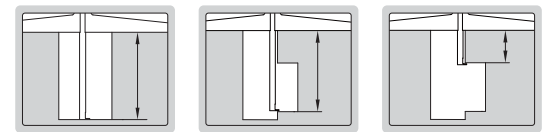

EXTENSION BASES



6141-260

- Supplied with two screws
- Made of stainless steel
- Suitable for depth gages series 1147, 1148, 1247, 1248 and 1249

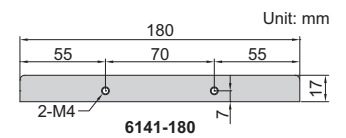

6141-180

Unit: mm

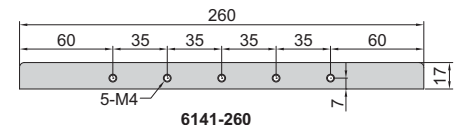

6141-260

Code	Length
6141-180	180mm
6141-260	260mm
6141-320	320mm

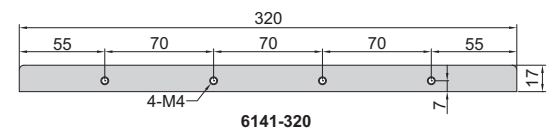
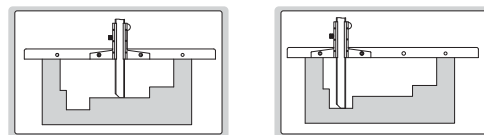

6141-320

VERNIER DEPTH GAGE (ECONOMIC TYPE)

- Graduation: 0.1mm
- Made of stainless steel



1244-30

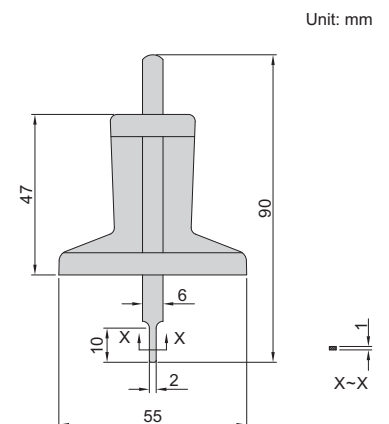

Unit: mm

Code	Range	Accuracy
1244-30	0-30mm	±0.10mm